

# APZ1-650

## Shower drain with an edge for perforated grids

### Application

- For indoor use
- For drainage of floor-level showers
- For installation into open spaces or near the wall of the shower area
- For perforated stainless steel grids
- For wheelchair access

### Features

- Stainless steel shower drain (perfectly smooth and durable surface thanks to special surface treatment)
- Installation height from 85 mm
- Adjustable height
- Trap firmly connected to the drain – 100% waterproofing
- Self-adhesive tape for quality waterproofing
- Mechanically cleanable trap up to the waste pipe
- The collar and trap are protected by foil, and the channel itself by a polystyrene insert
- The high flow rate is achieved due to the double compartment trap system
- Possibility to buy a combined odour trap
- 25 years guarantee
- Material of shower drain: stainless steel 2 mm, AISI 304, DIN 1.4301, EN1253-1
- Trap material: polypropylene

### Scope of supply

- The shower drain is assembled with the odour trap
- Fixation set: screws Ø6x50 – 2 pcs, dowels Ø10 – 2 pcs
- Self-adhesive waterproofing tape
- Protective foil covering for the drain edges and odour trap
- Protective film for trap inlet
- Installation trough cover - polystyrene

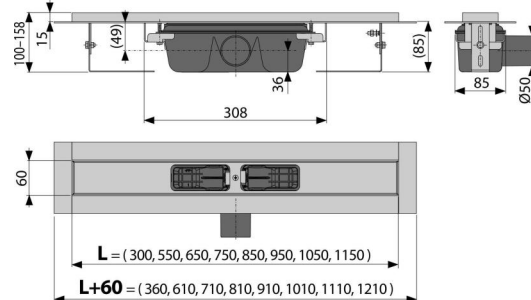

### Order number, Logistic information

Code	EAN	Weight (piece   packing   palett)	Dimensions (piece   packing)	Quantity (packing   palett)
APZ1-650	8594045932928	650 mm 3,11   37,35   132,1 kg	720x135x170   mm	12   36 pcs

<b>Warranty</b> 2/25 years *	<b>Norms</b> EN 1253
---------------------------------	-------------------------

### Technical specifications

- Odour trap 50 mm
- Flow rate 60-68,8 l/min
- Resistance of odour trap against the pressure 982 Pa
- Waste pipe diameter 50 mm
- Minimum thickness of concrete 85 mm
- Total installation height 100-158 mm
- Load class K3 300 kg