

A55ANTIC-120

Bath pop-up waste and trap, length 120 cm, metal, bronze-antic

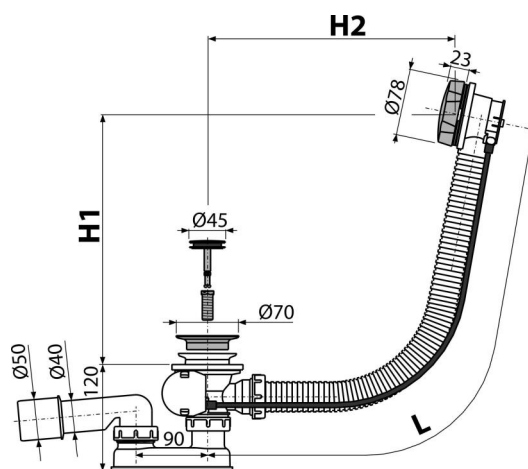

Application

To drain the water from the bath to the waste
For standard size bathtubs
For bathtubs with drain outlet Ø52 mm

Features

- Bath waste and overflow system
- Wet odour trap with swivel elbow
- Closing waste by pop-up mechanism
- Overflow flexi pipe
- The length of the bathtub trap 120 cm

Scope of supply

- Waste and trap body with overflow
- Metal control knob with bronze-antic finish
- Metal plug with bronze-antic finish
- Metal outlet grid with bronze-antic finish
- Odour trap of polypropylene, thermally and chemically resistant, longitudinally welded
- Assembly kit
- Profiled seal

Order number, Logistic information

Code	EAN	Weight (piece packing palett)	Dimensions (piece packing)	Quantity (packing palett)
A55ANTIC-120	8595580541309	0,89 17,74 303,8 kg	380×85×145 mm	20 320 pcs

Warranty

2/3 years *

Norms

EN 274

Technical specifications

- Odour trap 50 mm
- Flow rate 51,6 l/min
- Overflow flow rate 42 l/min
- Resistance of odour trap against the pressure 588 Pa
- Thermal resistance 95 °C