

APZ13-DOUBLE6-950 Fit and Go

Shower drain with an edge for two-sided grid

Application

- For wheelchair access
- For drainage of floor-level showers
- For installation into open spaces or near the wall of the shower area
- For indoor use

Features

- Design is determined by double-sided grid DOUBLE - from one side it is a full grid made of stainless steel and the other side has an option for embedding tiles or waterproof wood to the thickness of 12 mm
- Shower drain material: stainless steel 1.5 mm, AISI 304, DIN 1.4301
- Shower drain made from one piece of stainless steel sheet
- Linear drain from stainless steel (hardened by pickling, passivation and electrochemical polishing)
- Self-adhesive tape for quality waterproofing
- Gradient of inner part of the shower drain body
- Installation height 54 mm
- The shower drain body is protected by the polystyrene insert
- Adjustable height
- 25 years guarantee

Scope of supply

- Dismantling hook
- Fixation set for attaching adjustable legs: screw 4.2x38 – 4 pcs, anchor – 4 pcs
- Comb for applying glue into the grid frame
- Installation trough cover - polystyrene
- Combined odour trap SMART
- Two-sided grid DOUBLE (full grid or grid for embedding tiles)
- Protective foil covering for the drain edges and odour trap
- Protective film for trap inlet
- Supports 2 pcs
- Self-adhesive waterproofing tape
- Trap for shower drain APZ-S6
- Linear shower drain

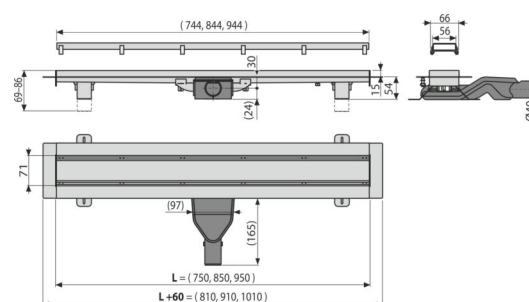

Order number, Logistic information

Code	EAN	Weight (piece packing palett)	Dimensions (piece packing)	Quantity (packing palett)
APZ13-DOUBLE6-950	8595580572112	6 mm 3,95 47,41 162,2 kg	1057x147x100 1080x780x410 mm	12 36 pcs

Warranty
2/25 years *

Norms
EN 1253

Technical specifications

- Total installation height 69-86 mm
- Minimum thickness of concrete 54 mm
- Resistance of odour trap against the pressure 270 Pa
- Waste pipe diameter 40 mm
- Flow rate 40 l/min
- Load class K3 300 kg
- Odour trap 31 mm